

HYGROFLEX7



THE HEAVY DUTY TRANSMITTER

INTRODUCING AIRCHIP DIGITAL TECHNOLOGY

INNOVATION IN HUMIDITY AND TEMPERATURE MEASUREMENT

- Relative humidity, temperature measurement and dew point calculation
- Outstanding accuracy and repeatability
- Hygromer® IN-1 Humidity Sensor
- Auto-diagnostics with error compensation
- All metal construction
- Freely selectable and scalable analog outputs



SPECIFY THE BEST: HYGROFLEX7 ADVANTAGES AT A GLANCE.

The new HygroFlex7-series are equipped with sturdy metal housings and stainless steel probes for harsh industrial conditions. Based on AirChip3000 technology, this indicator achieves a degree of accuracy not seen before. Every transmitter can be used as a simulator with fixed values. This is a major advantage in system configuration and validation.

The HygroFlex7 transmitter offers, depending on the model, an application range of $-100\dots+200\text{ }^{\circ}\text{C}$. Thanks to its fire protection classification, the instrument is perfectly suited for industrial applications, is convincing in process monitoring and in environments such as building management. Subway and tunnel construction also benefit greatly from the services provided by the HygroFlex7.

Housing

- Robust industrial housing
- Ideal fire protection classification and degree of protection for your application
- All metal construction for wall, cable and duct versions
- Display of the measured values on a clear, backlit graphic display with trend indicators

Output signals

- Two freely selectable and scalable analog outputs
- Dew/frost point and moisture calculation
- 2-wire and 3/4-wire versions available
- Use as a simulator for system validation
- UART service interface



TECHNOLOGY

AirChip3000

- Compensates humidity and temperature over 30,000 reference points
- 2,000 data point memory
- Dew/frost point calculation
- Sensor auto-diagnostics and automatic correction
- Active alarming and information
- ASIC (Application Specific Integrated Circuit), micro-controller and EEPROM on one chip

Fast response and precise measurement

- Fixed mounted stainless steel probes for wall and duct mounts, cable probes with Teflon cables
- Superb system accuracy



APPLICATIONS

The HygroFlex7 transmitters are ideal in harsh industrial environments. Whether in industrial applications, building management systems, underground railways, tunnelling etc. there is hardly a field today in which exact measurement of humidity, temperature and dew/frost point may be ignored. It is ultimately the measuring task at hand that defines the instrument that best meets your needs.

HF7 wall mount

Building management system,
Underground railways and tunnelling



HF7 cable mount

Industrial processes in harsh environments,
building management systems



HF7 duct mount

Industrial processes in harsh environments,
air delivery and exhaust equipment



OUTPUTS OF THE HYGROFLEX7-SERIES

The high flexibility of the HygroFlex7-series allows the user to freely select the output parameters and the scale of each output. All you need to do is enter the desired settings using HW4 software (0...1V, 0...5V, 0..10V, 0/4...20mA).

HF72-series

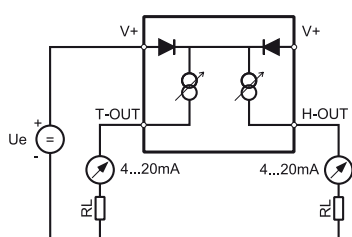

Schematic 2-wire type
(current signal)

HF73-series

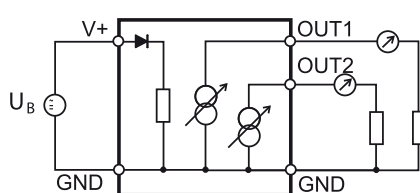

Schematic 3-wire type
(current signal)

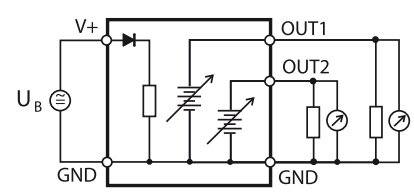

Schematic 3-wire type
(voltage signal)

TECHNICAL INFORMATION

Probe Output Signal.

When connected to a PC the HygroFlex7-series probes can be rescaled with different ranges to suit the application. It is also possible to assign the internally calculated dew or frost point value to one of these outputs.

Sensor Diagnostics.

The intelligence of AirChip3000 technology enables advanced sensor diagnostics. Should the sensors deviate from factory defined parameters, measurement values can be compensated automatically and a digital alarm triggered.

Wall mount (W)

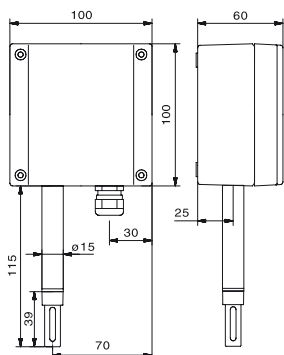

Cable mount (C) *

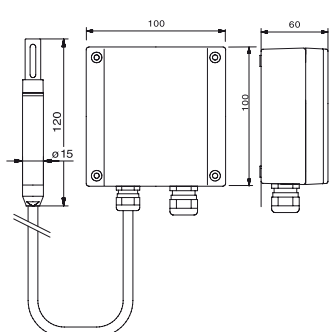

Duct mount (D)

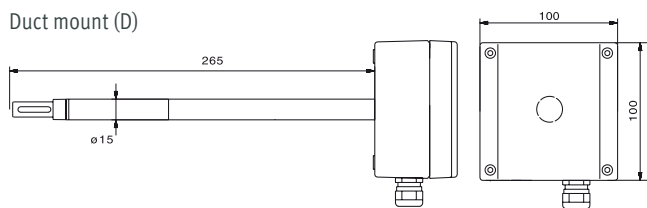

Duct mount (D) *

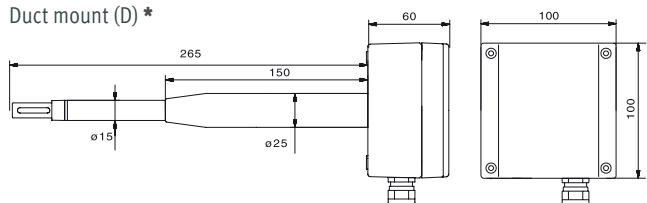

| | HF72 2-wire | HF73 3/4-wire |
|-------------------------------------|--|--|
| Integrated sensors | Yes | |
| Humidity sensor | ROTRONIC Hygromer® IN-1 | |
| Temperature sensor | Pt100 1/3 Class B | |
| Accuracy at 23 ±5 °C | ±1.0 %rh / 0.2 K | |
| Resolution AirChip3000 | <0.02 %rh / 0.01 K | |
| Long-term stability humidity sensor | <1 %rh / year | |
| Response time τ 63 | <10 s | |
| Start-up time | Typical 1.4 s | Typical 1.9 s |
| Measurement range (probe) | -100...100 °C / 0...100 %rh (type W) * -100...150 °C / 0...100 %rh (type D) -100...200 °C / 0...100 %rh (type C) * | |
| Electronics operating range | -50...100 °C / 0...100 %rh (-10...60 °C with LCD) | |
| Display type (option) | Graphic display, backlight | |
| Output signals | 4...20 mA | 0...1 V, 0...5 V, 0...10 V 0...20 mA, 4...20 mA |
| Change of signal U/I | HF73 only, without adjustment | |
| Power supply | 10...28 VDC, 4...20 mA | Depending on the output signal configuration |
| Power consumption | 2x 20 mA, 4...20 mA | <50 mA |
| Circuit types | 2-wire types | 3/4-wire type |
| Maximum load per analog output | 500 Ω | ≤ 500 Ω (mA - signal) ≥ 1 kΩ (V-signal) |
| Firmware update | Yes, requires HW4 software | |
| Sensor Diagnostics | HW4 programmable. Default: off | |
| Sensor protection | Filter carrier (order filter separately) | |
| Maximum air velocity at probe | 40 m/s - depends on filter type | |
| Adjustments | Yes, with HW4 software | |
| Data logging function Internal | Yes, 2000 data point memory | |
| Dewpoint /frostpoint calculation | Yes | |
| PC interface, UART | Yes, HW4 compatible | |
| Data processing by HW4 | Graphs, statistics, analyses, qualification etc. | |
| Housing material / weight | Aluminium diecast / Approx. 800 g | |
| Cable connections | 1 x M16x1.5 or 1/2" Conduit Adapter | |
| Standards | CE-compliant, 2007/108/EG | |
| Audit trail, Electronic Records | FDA CFR21 Part 11 and GAMP compliant | |
| IP protection rating & fire | IP65 (Incombustible) | |

* On demand: Special versions with PPS probe material (-100...+200 °C)

Interested in further information (special applications, order codes)? A complete and up-to-date overview of our HygroFlex7-series is available on our web site www.rotronic.com.

Change over now to the HygroFlex7 transmitter and HygroClip2 probes with the integrated AirChip3000 for your humidity and temperature measurement needs. You can find detailed information about our probes at www.rotronic.com. We would also be happy to advise you in person or on the phone.

rotronic
MEASUREMENT SOLUTIONS

ROTRONIC AG, Grindelstrasse 6, CH - 8303 Bassersdorf, Tel. +41 44 838 11 11, Fax +41 44 836 44 24, www.rotronic.ch
ROTRONIC Instruments (UK) Ltd, Crompton Fields, Crompton Way, Crawley, West Sussex, RH10 9EE, UK, Phone +44 (0)1293 571000, Fax +44 (0)1293 571008, www.rotronic.co.uk
ROTRONIC Instrument Corp, 135 Engineers Road, Hauppauge, NY 11788, USA, Phone, +1 631 427-3898, Fax, +1 631 427-3902, www.rotronic-usa.com